

Hand-Stitched Charm Quilt Pattern

By Wanda A. Dotson

<https://wandadotson.com/>



Finished Quilt Size: 40.5" by 40.5"
Optional: 81" by 81"

In this quilt, I used a 100-piece 5" Charm Pack from Free Spirit's Denyse Schmidt Modern Solids. The strips are applied to individual charms then assembled in a 9-patch block. There are Nine (9) 9-patch blocks.

Materials:

100 5" Charms

Backing: 1 ½ yards

Batting: 1 ½ yards

Binding: ½ yard (specifically 5 strips of 2.5" width across width of fabric)

APPLIQUE INSTRUCTIONS

Supplies:

5" Charm Pack of 100 pieces or 5" Squares

Scissors

80 Weight Thread

Applique Needles

Pins

Thimble

Marking Tools

You will start at the top of the pile of 100 charms and choose the next color or high contrast charm as the mood strikes you. I used Free Spirit's Denyse Schmidt Modern Solids. The images in the Quilt Instructions show the choices I made. They do not represent the actual colors from Free Spirit Fabrics, but they are in the color range. I have no association with Free Spirit Fabrics. This pattern will work with any charm pack or from your scraps. **THERE'S A COLORING BOOK ON THE LAST PAGE.**

NOTE: When possible you will need to cut away the bottom charm to make more strips for the appliques on the other charms. This will be possible when you use a large strip.

First Thing: Pick two charms.



5" square



5" square

Cut one of the charms into strips with your scissors. It doesn't have to be perfectly straight.



Attach strips to the other charm with pins.

Put aside the other strips to use on another charm.

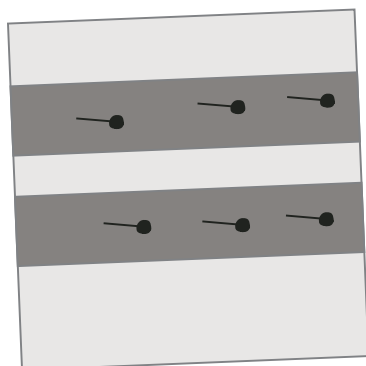

To begin, mark the strips one-quarter inch from the edge. Chalk or a pencil works.

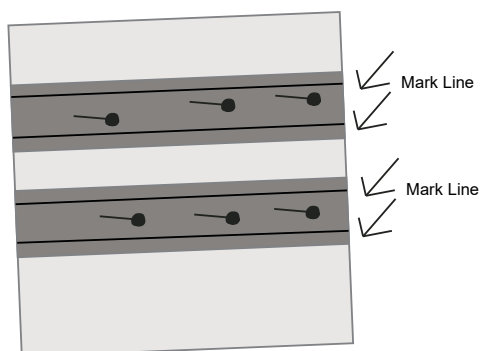

Thread your needle. About 12-14" long. Add your favorite knot at the end. I use John James Gold 'n Glide appliqué size 11. You are now ready to needle turn the strips.

Since these are straight, you can turn the quarter inch in with your fingers to start.

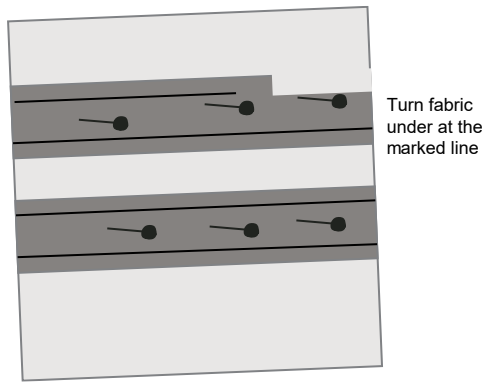

Stitch the edges down about every one-eighth of an inch, catching the edge of the strip.

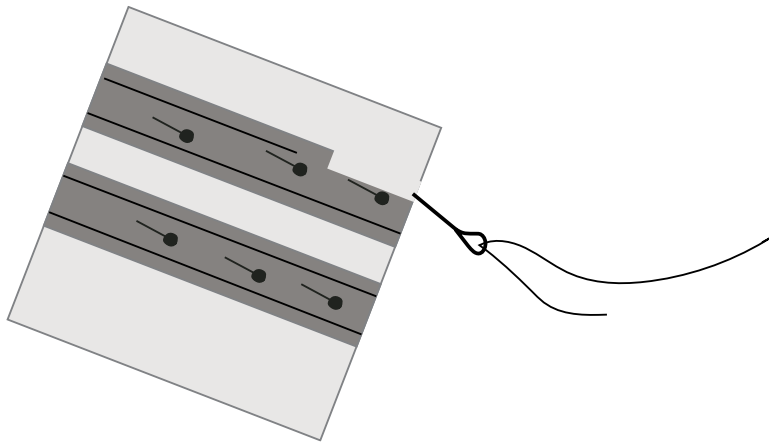

Continue until the end and knot at the end on that strip. Then start on the other side.

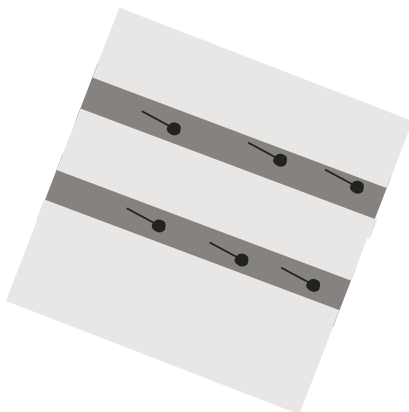

Trim to 5" square.

QUILT ASSEMBLY

Materials:

56 Appliqued Blocks

25 Non-appliqued Blocks (Charms)

This is a giant 9-patch quilt.

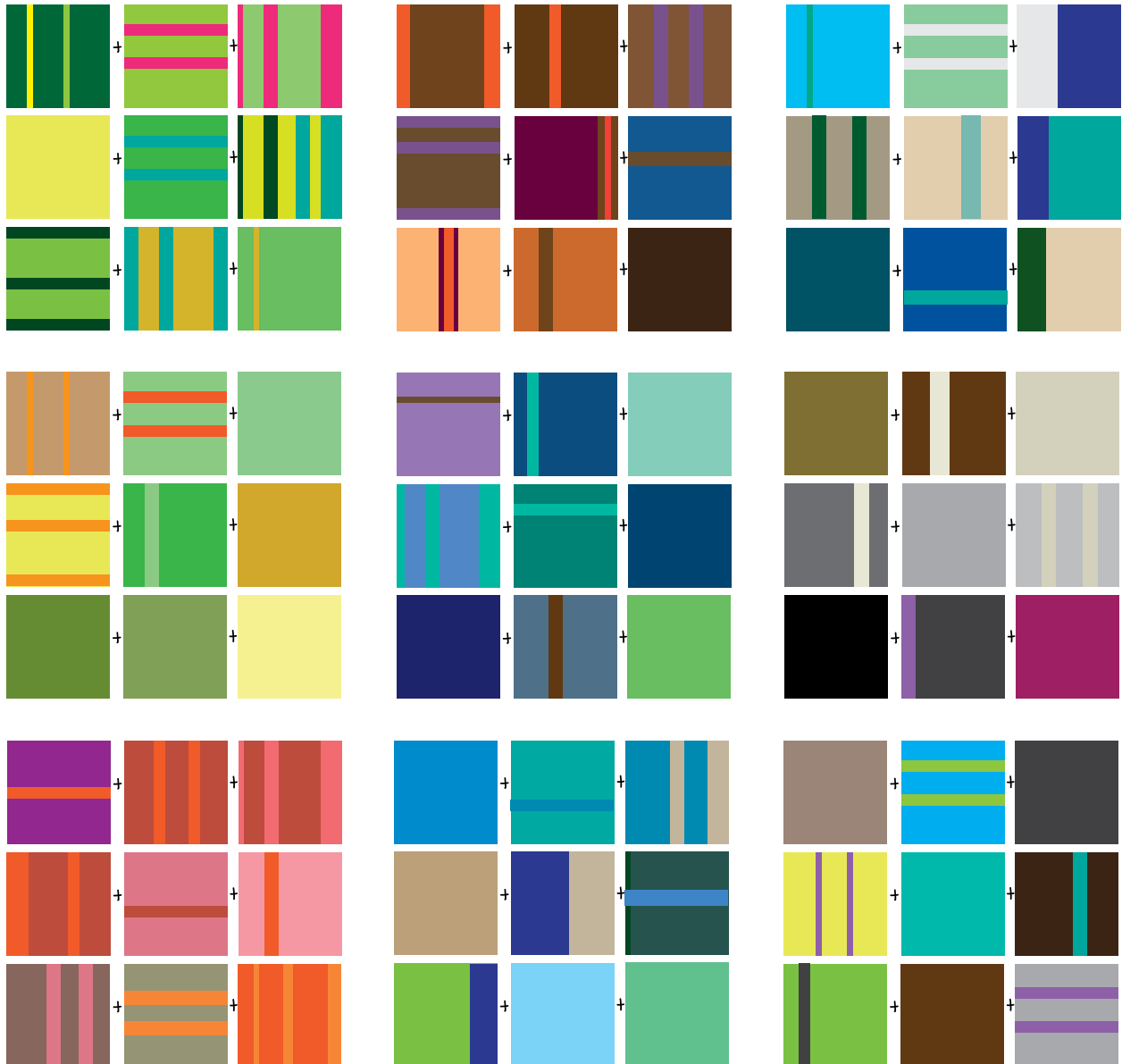

Assembly the first 9-patch, top left corner of quilt, as shown. Press as preferred. If pressing to one side, be mindful of the adjoining seam. You will want them to nest together. The block is 14" square unfinished.

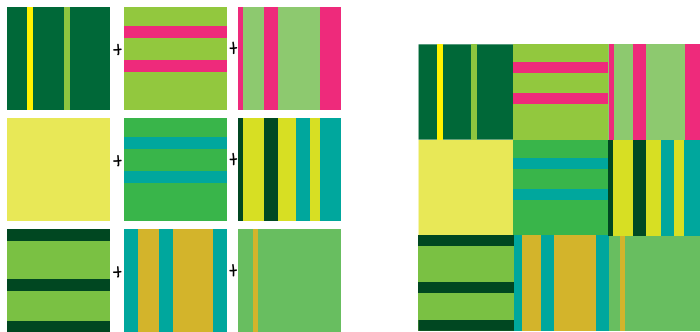

Then MAKE TWO (2) MORE 9-PATCH BLOCKS FOR ROW 1

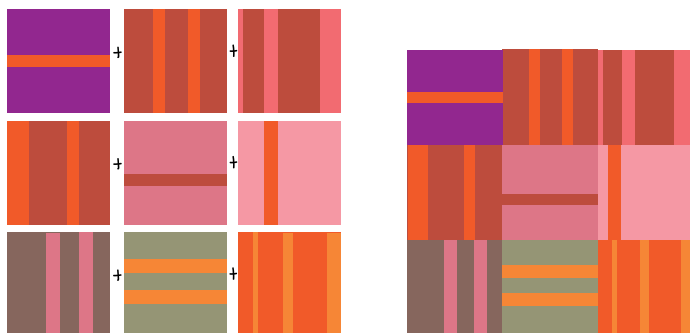
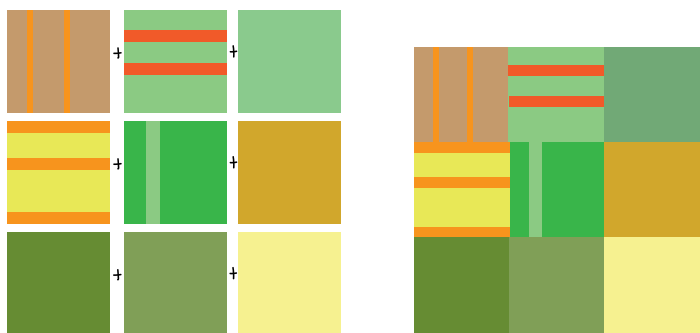

Sew the three 9-patches together. Press as preferred.

MAKE THREE (3) 9-PATCH BLOCKS FOR ROW 2

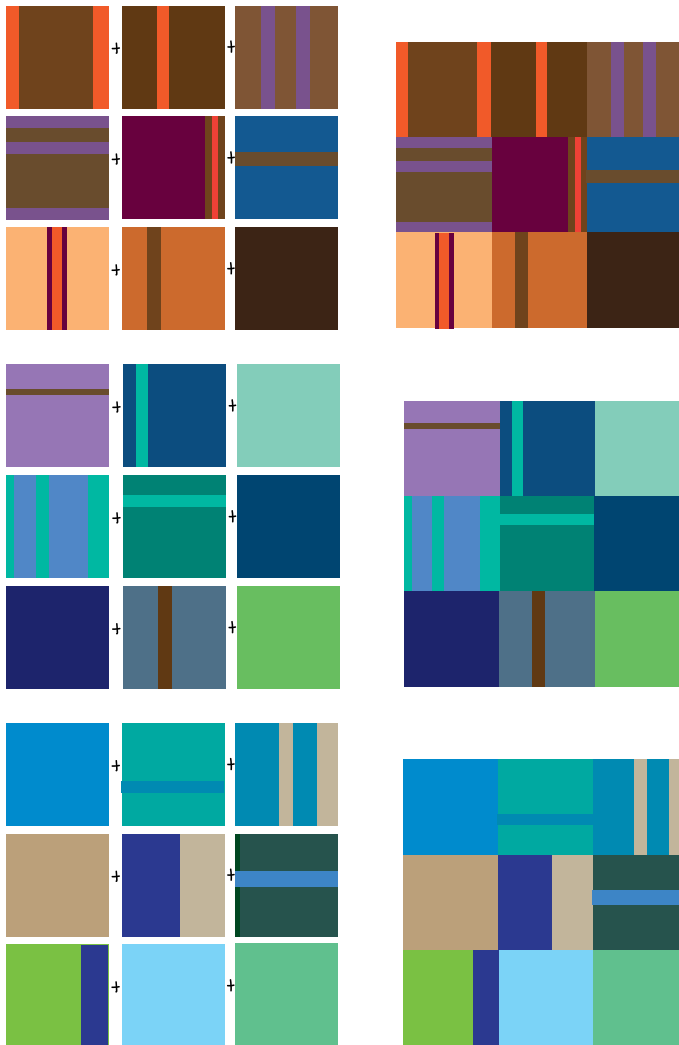

Sew the three 9-patches together. Press as preferred.

MAKE THREE (3) 9-PATCH BLOCKS TO MAKE ROW 3

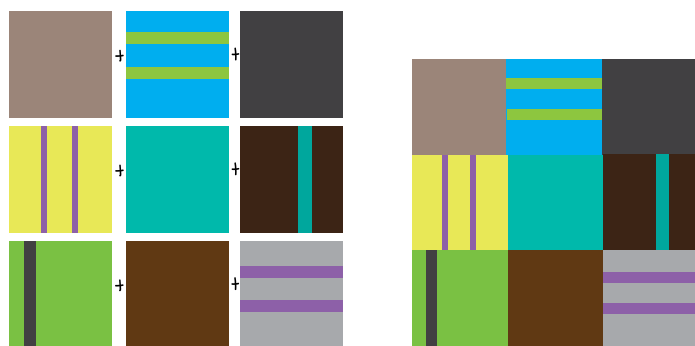
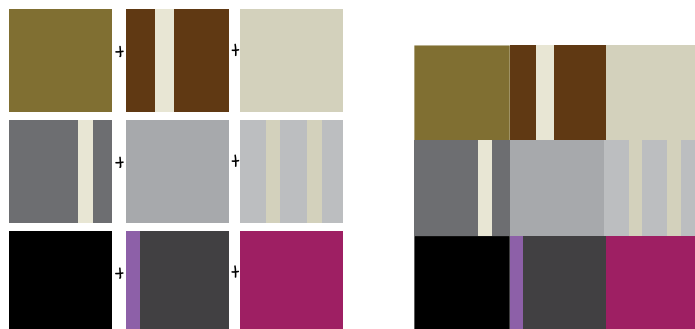
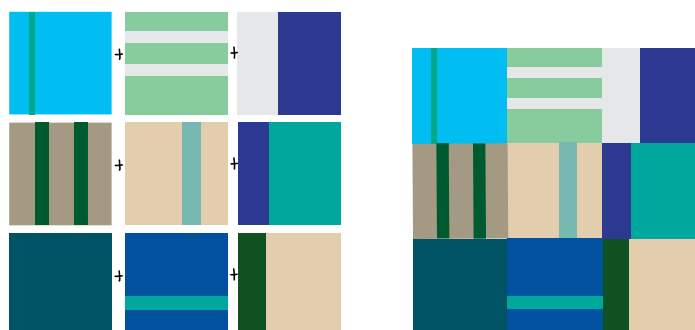

Sew the three 9-patches together. Press as preferred.

You should now have three rows. See next page.

ROW 1



ROW 2

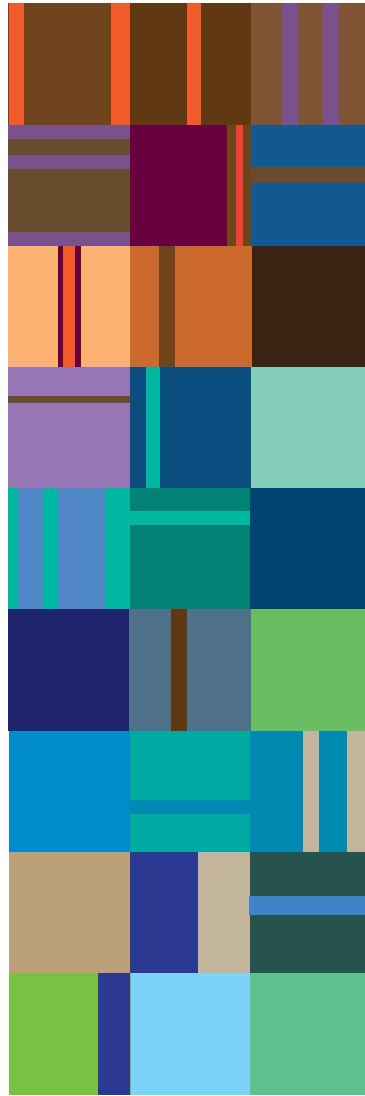

ROW 3

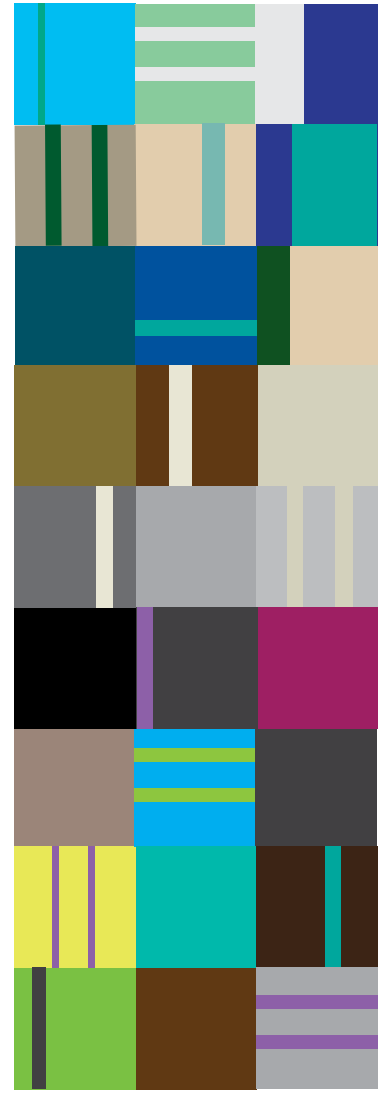

Sew Row 1 to Row 2. Press as preferred.

Sew the Row 1/2 Unit to Row 3. Press as preferred.

The final assembly should look like this:

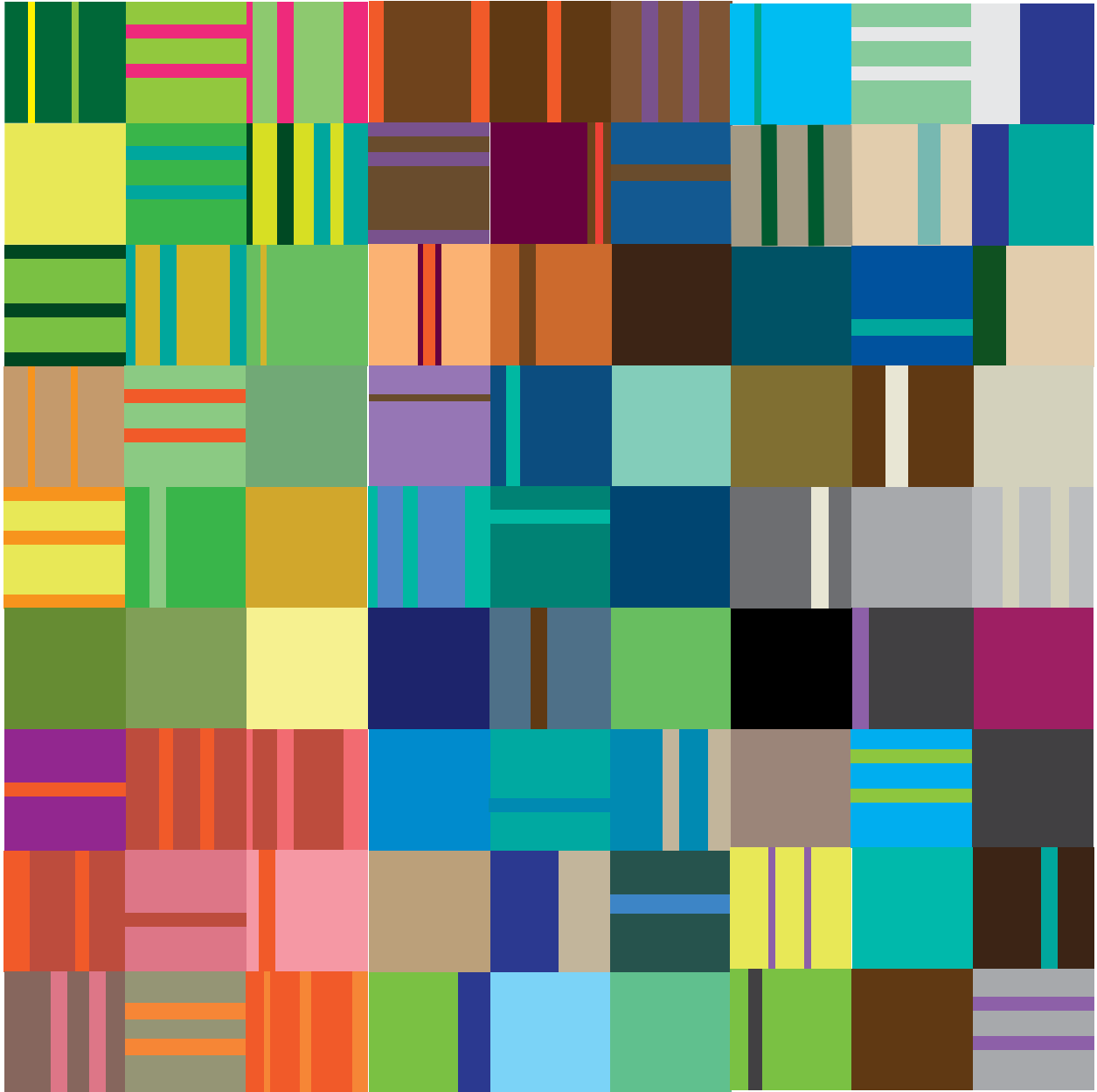

Baste and quilt as desired. I hand quilted mine and tried to echo the strips and add hand quilted “strips” to the solid charms.

Use your favorite binding technique. I used faced binding.

Optional:

Make four (4) of the 41.5" square tops for 81" square quilt:

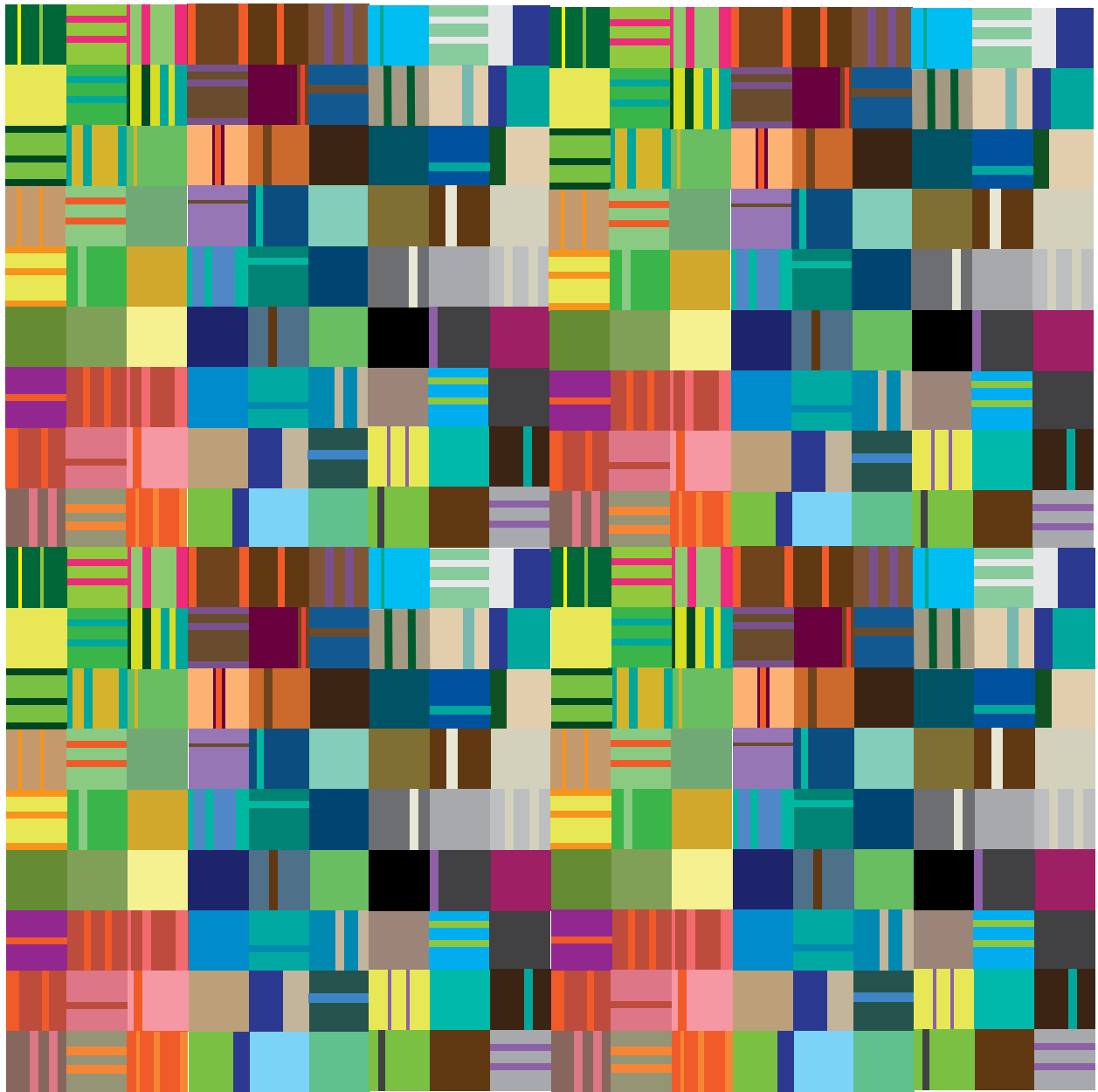

Hand-Stitched Charm COLORING BOOK

